

## Surveying & Installation : Guide





**DURAFLEX**  
MAKING THE DIFFERENCE

■ <u>Surveying &amp; Installation</u> - Introduction	Page 3
■ <u>Surveying &amp; Installation</u> - Terminology	Page 4 - 5
■ <u>Surveying</u> - Replacement Window and Doorsets	Page 6 - 11
■ <u>Surveying</u> - Removal of Window and Doorsets	Page 12
■ <u>Site Safety</u>	Page 13
■ <u>Installation</u> - Window and Doorsets	Page 14 - 19
■ <u>Examples</u> - Typical Checklists	Page 20 - 21
■ <u>Removal Techniques</u> - Window and Doorsets	Page 22 - 25
■ <u>Frame Positions and Joint Construction</u>	Page 26 - 28
■ <u>Notes</u>	Page 29 - 30
■ <u>Bibliography</u>	Page 31





## Surveying & Installation - Introduction









- As of March 2007, British Standard **BS 8213-4: 2007** came into effect, the Code of Practice for the Survey and Installation of Windows and External Doorsets. In previous years the code of practice was issued by the BPF (British Plastics Federation) however, this has now become a more controlled and managed document under the British Standard flag.
- The document is used as a basis for obtaining a BSI kitemark for Surveying and Installation.
- The BS 8213 gives recommendations for the surveying and installation of **NON LOADBEARING** windows and doorsets of any material, which are installed vertically into the external face of a structure.
- The standard gives guidance on good practices necessary for successful surveying and installation of windows and doorsets into new build and replacement situations.
- The standard is mainly aimed at installation of frames into dwellings, however much of the document guidance can also be relevant to other types of installation.
- The document however does not cover curtain walling or load bearing windows and doorsets.





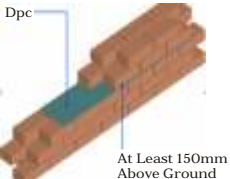
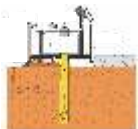



### **BS 8213 - 4: 2007** **Windows, Doors and Rooflights -**

Part 4: Code of Practice for the Survey and Installation of Windows and External Doorsets

# Surveying & Installation - Terminology

<p><b>Bay Window:</b></p>	<p>When three or more frames are fixed together and they all project beyond the main face of the building. The brickwork above and below the window frames follow the contours of the actual window frame, therefore allowing a person inside the building to walk into the bay area created.</p>	
<p><b>Bow Window:</b></p>	<p>A type of bay window, usually carrying only light loads, which does not form an extension to the floor area of the room.</p>	
<p><b>Door Assembly / Door set:</b></p>	<p>Complete assembly as installed, includes the door frame, the door sash together with the hardware</p>	
<p><b>Dormer Window Or Mansard Roof:</b></p>	<p>Vertical, or near vertical (up to 15°), window built into and projecting from a pitched roof structure.</p>	 <p style="text-align: center;">Mansard                      Dormer</p>
<p><b>DPM (Damp Proof Membrane):</b></p>	<p>A layer or strip of impermeable material, placed within a wall, chimney or similar constructions to prevent the passage of moisture</p>	 <p style="text-align: right;">Dpc At Least 150mm Above Ground</p>
<p><b>Finishing:</b></p>	<p>Final covering and treatment of surfaces E.g: Plaster, Render, Cladding etc</p>	
<p><b>Fixing:</b></p>	<p>Component that is used to secure separate parts of the window or doorset to each other, to secure an item of hardware to a window or door part or to secure the completed window or doorset into the structural opening.</p>	
<p><b>Frame:</b></p>	<p>Surround to a door leaf, window sash etc enabling it to be fixed into position, also referred to as an Outerframe.</p>	
<p><b>Gallows Bracket:</b></p>	<p>A triangular bracket used on the underside of a bay / bow window construction to provide support (See bay / bow window)</p>	
<p><b>Installation Packer:</b></p>	<p>Packing piece used in gaps at fixing points to obtain rigid fixing and prevent distortion (Also known as a <i>fixing packer</i>) - Usually a "U" Shape made of plastic.</p>	

# Surveying & Installation - Terminology

<b>Installer:</b>	Company and / or individual carrying out the works of fitting the window / door.	
<b>Lintel:</b>	Beam which supports loads over a structural opening. Can be made of steel, reinforced concrete, timber etc or steel mesh fixed between brick courses.	
<b>Manufacturing Sizes:</b>	The overall dimensions for the door / window which result from making the appropriate deductions from the structural opening size. Also known as Work Size.	
<b>Structural Opening:</b>	Aperture in a wall into which a window or doorset is to be installed.	
<b>Structural Opening Size:</b>	Size of the maximum rectangular shape which can be fitted within the structural opening.	
<b>Surveyor:</b>	Qualified or otherwise competent person who is capable of surveying for window and doorset installation, advising on suitable design, carrying out a risk assessment as necessary, and assessing the quality of the finished installation.	
<b>System Supplier:</b>	Original source of the design and / or supply of components used in the fabrication of a window or door.	
<b>Sealant:</b>	A compressible material used to seal around the perimeter of a window / door in the structural opening to prevent air and water penetration, commonly made of silicone, butyl tape, or polysulfide.	

## General: Surveyor

- **Good surveying** is the basis of **ensuring a quality installation**.  
Surveyors should be **fully trained in window and doorset installation techniques** and **be aware** of the **manufacturers recommendations** for the particular window / door system being used and **maximum manufacturing sizes**.
- In order to comply with the building regulations, it is advisable to **make notes and photograph** the window / door style which is being replaced along with sizes and of the opening lights and mullion / transom positions.
- The **surveyor** will be able to **inform** the purchaser / owner **of any enhancements** that could be made with respect to **security issues** and possible **ventilation**.
- **Risk assessment** must be carried out for **window / doorset design**.
- **Risk assessment** for the **installation** must also be carried out.
- Where **load-bearing situations** occur, the **system suppliers recommendations** must be followed.
- Check that **replacement window / doorsets** will **not infringe** any Local Authority **planning controls** i.e Conservation, Article 4 Direct.



**Make Notes**



**Take Photographs**



**Risk Assessment**

## General : Surveyor

- Surveyor to **check aperture for damage** / defects and inform purchaser / owner accordingly.
- **Check** if aperture has any **electrical wiring, telephone cables** etc present or near by.
- Check for **presence of curtain rails**. Important if the window/ door is inward opening.
- Surveyor should determine the **design wind load** for the application and whether the window / door is suitable for the application.
- The surveyor should **check** that there is a **lintel** present above the window / door or alternatively look into providing support should it be required.
- Bow, Oriel and Dormer windows may in some cases require to be **load bearing**, and therefore reference to the **system suppliers instructions must be made**.
- For coupled window / doorsets, the surveyor must determine the method to be used **taking into account wind and dead loads, aesthetics and coupling positions**.
- Ensure **BS8213-1** is complied with regarding window style to provide **safety in use and cleaning** (i.e Easyclean hinges)



Check Aperture  
for Defects



Check for  
Wires / Cables



Check for  
Curtain Rails



Wind Load  
Check



Check Lintel

## General : Surveyor

- Surveyor is to **confirm** with purchaser / owner whether the **window / door is be inward or outward opening** and confirm the handing. Note: Outward opening window / doors into pedestrian areas must be taken into account.  
**All surveys** are taken as being **viewed externally** - Always check and confirm this is the case.
- Surveyor is to **advise on restriction devices** particularly on outward opening windows / doors to prevent damage caused by sudden wind gusts.
- Surveyor when dealing with doorsets should take into consideration the **threshold types (Disability access), letterplate sizes and positioning, hardware specification and side panel specifications** all clearly identified to the purchaser / owner.
- Where **bricks are to be removed** to install a product, the **cavity closing method** must be **specified**. It is recommended that you **consult** the local authority **building control** for advice and interpretation of local regulations.
- The surveyor should specify or **confirm** the **drainage method** for the window / door frame and / or glazing.
- **Glazing**, including position, style, orientation, pattern / decoration, lead, georgian bar should be specified by the surveyor.

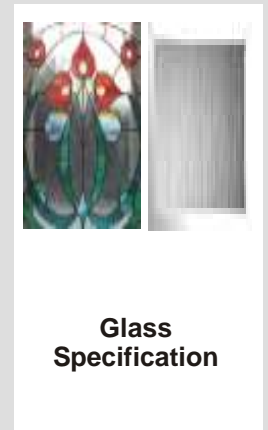
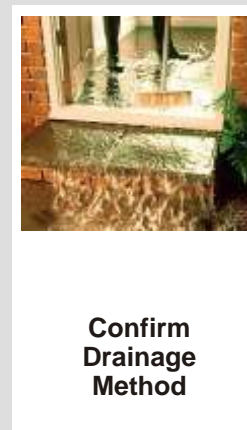
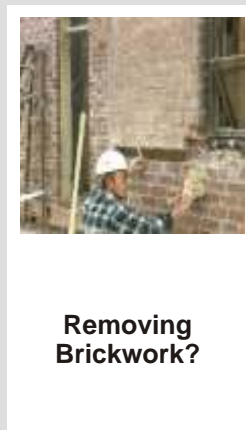
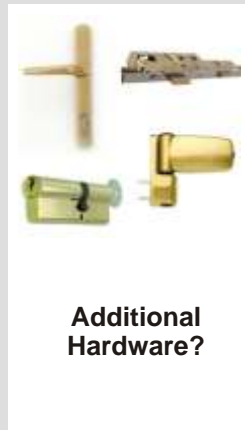

## General : Surveyor

- The surveyor should indicate safety glass requirements and positions in accordance with the Building Regulation (Approved Document N) where appropriate.

### Approved Document N - Part N1 - Glazing - Protection Against Impact

Glazing with which people are likely to come into contact whilst moving in or about the building shall:

- If broken on impact, break in a way which is unlikely to cause injury, or
- Resist impact without breaking, or
- Be shielded or protected from impact.

Part N1 specifies the areas where safety glazing is required to be installed and is supported by by detailed British Standard documentation.

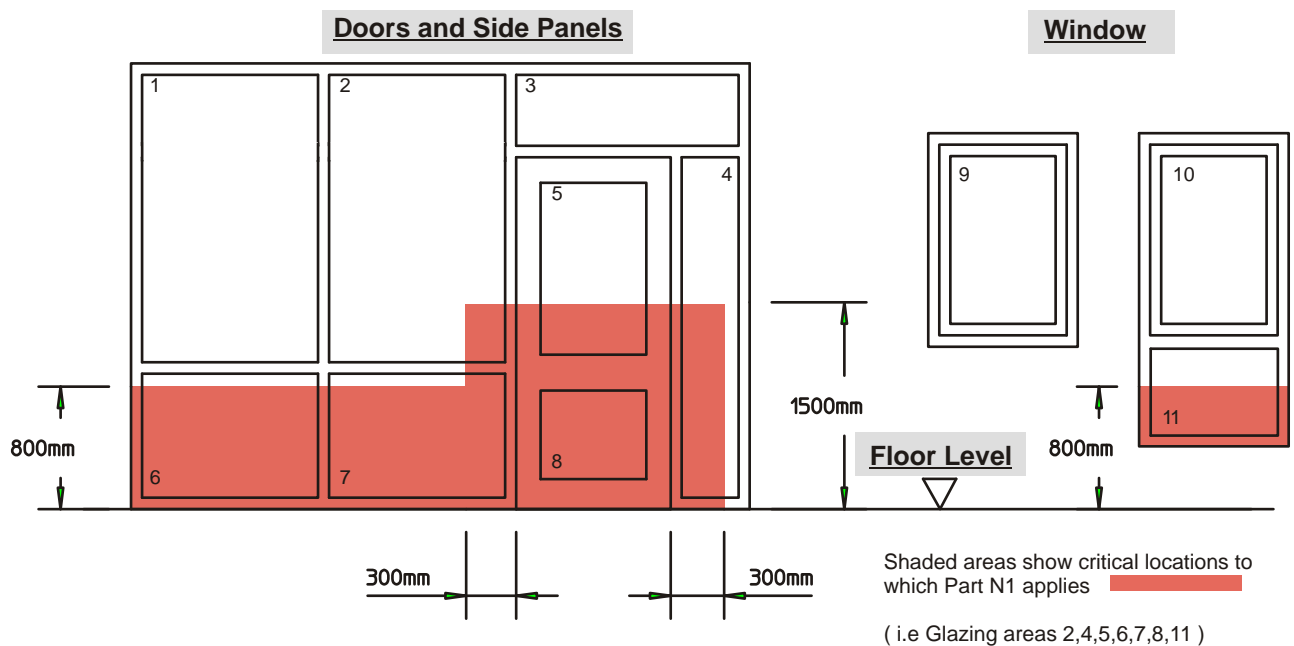

### Critical Locations in Internal and External Walls - Part N1

## General : Surveyor

- **Measurement of an opening:** Three measurements of **width** and **height** should be taken across the opening, along with the squareness of the aperture by taking **diagonal** measurements. The **smallest measurement** of height and width will **determine the manufacturing size**.

### Measurement of Flat Windows & Doorsets

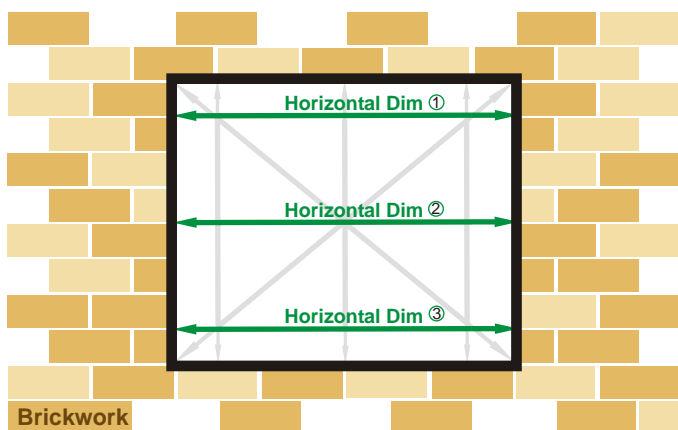

Step 1: Take 3no. Horizontal Dimensions

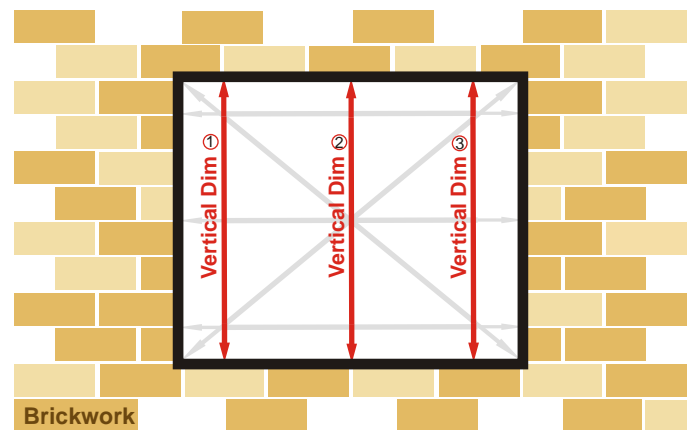

Step 2: Take 3no. Vertical Dimensions

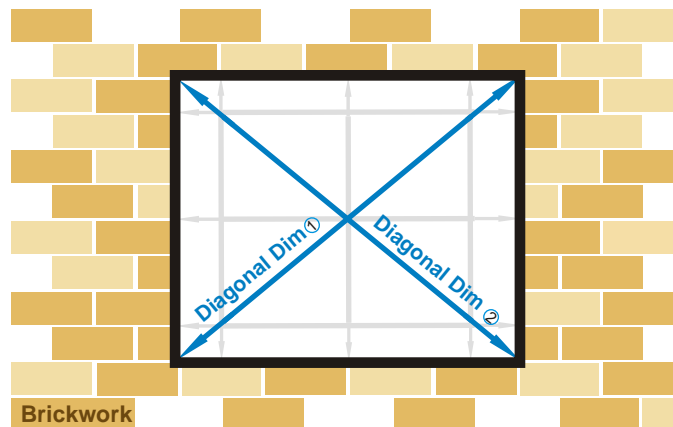

Step 3: Take 2no. Diagonal Dimensions

- The need for any sub-cill should be determined. The size of the sub-cill overhang should be such that it is an overhang of at least 25mm from the face of the brickwork to the inner edge of the cill overhang. The surveyor will determine the method of fixing, check requirements for cill horns and how any “making good” is to be carried out.
- The difference between internal and external reveal sizes should be determined and checks made to the operation of the opening light to ensure it is not impeded by plaster, render or tiles etc.

## General : Surveyor

- **Manufacturing Sizes:** Due to temperature fluctuations, PVCu windows and doors can expand and contract. This needs to be taken into account when calculating the finished frame size in relation to the aperture. The table below highlights the recommended deductions for the width and height of a frame.

Material:	Recommended Deduction for Width and Height of Structural Opening.			
	Up to 1.5m	From 1.5m to 3.0m	From 3.0m to 4.5m	From 4.5m
GRP	5	10	15	15
PVC-U : White	10	10	15	20
PVC-U : Non White	15	15	22	28
Timber	10	10	10	15
Steel	8	10	12	15
Aluminium	10	10	15	20

All dimensions in millimetres (mm)

- These deductions are from the TOTAL width and height, and not “per side”.
- The gap required for effective polyurethane foam fixing at the head is 10 - 15mm.
- NOTE: When the overall width or height exceeds 3.0m, intermediate expansion joints may be required.
- NOTE: BS7412 limits window sizes up to 3.0m only.

# Surveying - Removal of Existing Window & Doorsets

## General : Installer

- The installation team should **ensure** that all relevant **documentation** is available and **clearly understood**. i.e Drawings, Survey Sheets, Specialist Instructions etc
- **Check** and double check sizes, **type and condition** of all windows and doors against the survey sizes, type and against the actual aperture size, **prior to any removal operations**.
- Prior to commencement of work, the purchaser / owner must be given adequate notice to **remove any furniture**, fixings or fittings.
- The installer is responsible for both the external and internal protection of the property during installation work by the use of clean dust sheets. Avoid debris becoming embedded in soft garden areas.
- **Care should be taken** to avoid damage to floor coverings and to decorations.
- **Plan to install** and seal new windows and doorsets on the **same day** as the existing windows / doorsets are removed, to maintain security and weathertightness of the dwelling.
- Remove existing windows /doorsets without damaging the building structure and its finishings.
- **Electrical wiring** and other specialist cables should be **routed around and away** from the window / door and not through the frame. If this is not possible then it must be agreed by the purchaser / owner and surveyor as to an alternative solution and if required a specialist service provider brought in to assist with the routing of the cables etc.

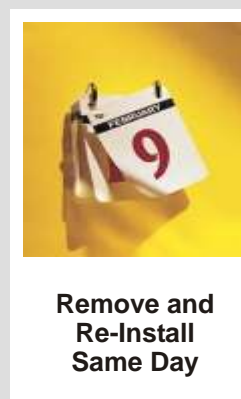

# Site Safety

\*\*\*\*\* Window and Doorset removal and installation can be dangerous \*\*\*\*\*

- Health and Safety at Work Act 1974 / Control of Asbestos at Work Regulations 2002.
- Train new operatives in the safe use of tools.
- Ensure operatives have and **use correct PPE (Personal Protective Equipment)**
- Full training and assessment records of operatives should be kept.
- Glass Handling: Wear eye protection, safety footwear, hand and wrist protection.
- All electrical power tools should: Work on 110 V mains power or
  - Be Battery operated or
  - Work on 240V with residual current detector of 30 mA maximum rating.
- The use of a safe working platform to give safe access to the structural opening is essential.
- When operating a grinding disc, safety precautions as follows should be observed:
  - Heavy Gloves, face visors and helmets must be Worn.
  - Clear access provided.
  - Care should be taken that sparks can not ignite combustible materials i.e dust sheets.
  - All personnel should be kept at a safe distance.
- Store and dispose of old windows and doorsets and other debris safely and **recycle where possible. (Recovinyl)**



Training



Personnel Protective Equipment

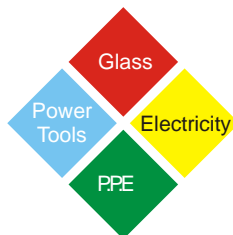

Think Safety!



Working Platforms



Storage and Disposal

## General: Installer

- The window / doorset must be fixed into the structural opening or to an adjacent window / doorset in order to resist all likely **imposed loads** which may cause the **frame to deflect**. These loads might be due to .....
- **Wind Loads**
  - **Operating Loads**
  - **Gravity (i.e Vertical Slider / Pivot / Casement)**
  - **Accidental Impact**
  - **Attempted Burglary**
- The fixing methods for the window / doorset can be affected by.....
- **The wall construction i.e cavity or not, materials**
  - **The nature and condition of any cavity**
  - **The relative position of the frame and cavity**
  - **The position of the plasterline and the need to minimize disturbance and damage to interior decorations**
  - **The design of the reveal**



## General: Installer

- Two methods of fixing window / Doorset into opening or as combinations:
  - **Through Frame Fixing**
  - **Fixing Lugs**
- Screw fixings should penetrate at least 25mm into timber, plugged holes in brick, block or masonry.

Connections to steelwork should be made using the appropriate thread cutting screws or with pre-tapped holes and a machine screw, or self drilling screws.

### Typical Frame Fixings



**Typical Fischer Window Fixing**



**Self Drill Masonry Fixing (Tapcon)**



**Machine Screw Fixing**

### Fixing Lug Detail

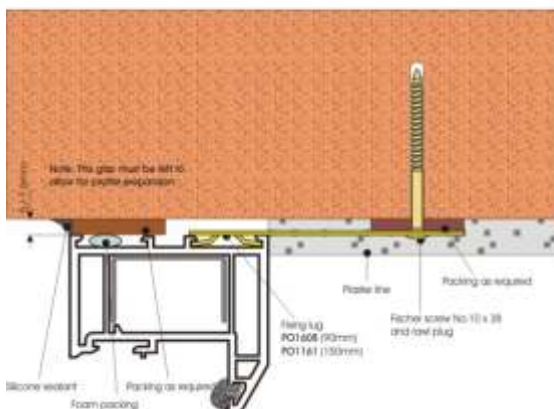

### Through Frame Fixing Detail

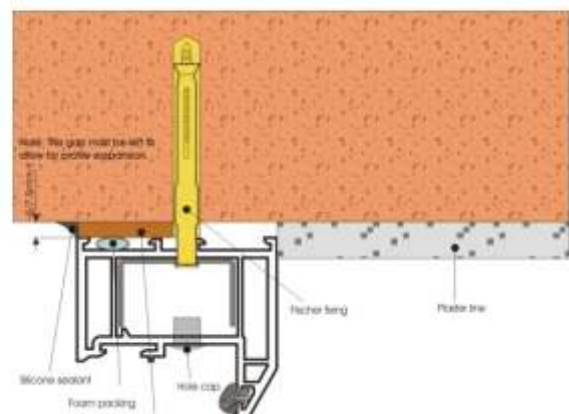

## General: Installer

### Fixing Distances and Positions for PVC-u Window & Doorset

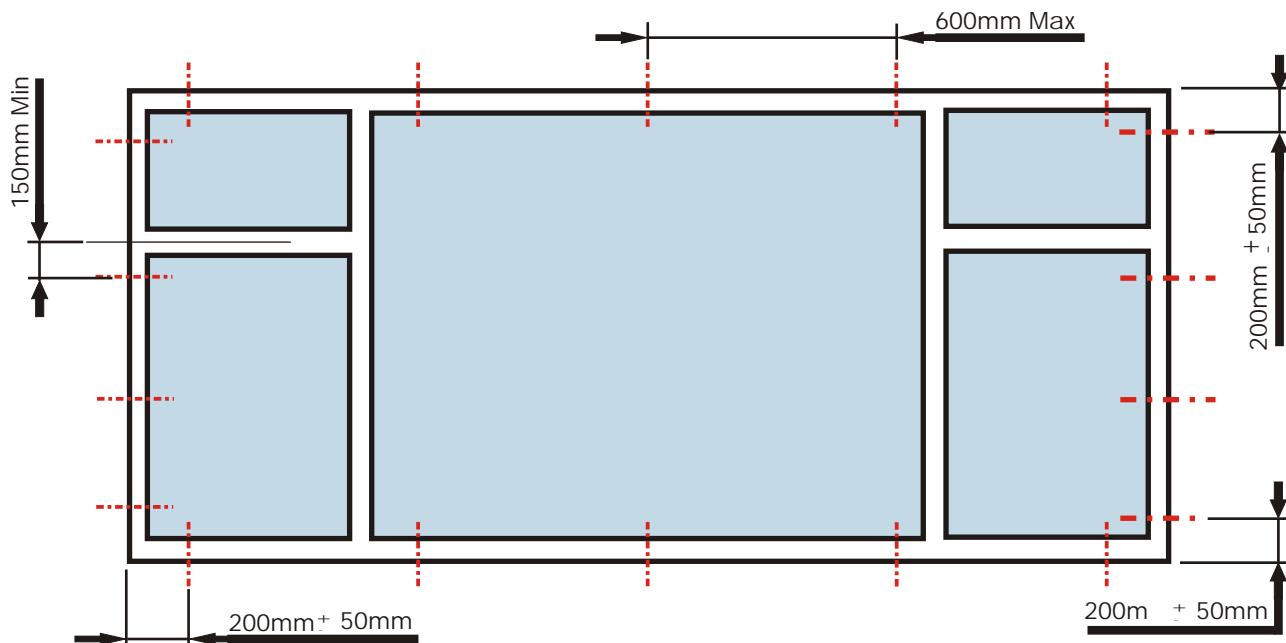

All four sides of the window / doorset, where practicable, should be fixed in the opening.

- Concrete and steel lintels can make it difficult to achieve the correct fixing arrangement.
- Polyurethane foam is known to be beneficial to such when used in conjunction with the fixings if the correct fixing distances can not be achieved.
- DO NOT USE polyurethane expanding foam as the sole method of fixing.
- Corner fixings should be between 150mm and 250mm from the external corner.
- Fixings should be a minimum of 150mm from the centre line of a transom / mullion.
- Each jamb and cill should have a minimum of two fixings with intermediate fixing being positioned at no greater than 600mm centres.
- If the head is fixed with polyurethane foam, the following rules may be applied.
  - Frame width upto 1200mm- No fixings
  - Frame width 1201mm to 2400mm- One central fixing
  - Frame width 2401mm to 3600mm- two equally spaced fixings

## General: Installer

### Fixing Lugs

- If used as an external lug, use either a "One Way" or security screw fixings.

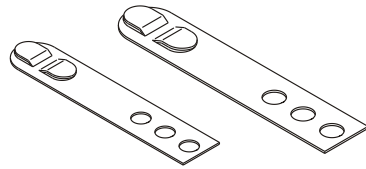

### Finishings

- Trims etc may be used to complete the interface of the frame and structure. DO NOT use the trims as a way of enhancing the weathertightness.

### Coupled Assemblies

- Coupled assemblies are delivered to site as separate units and fixed in position in accordance with the system suppliers recommendations.

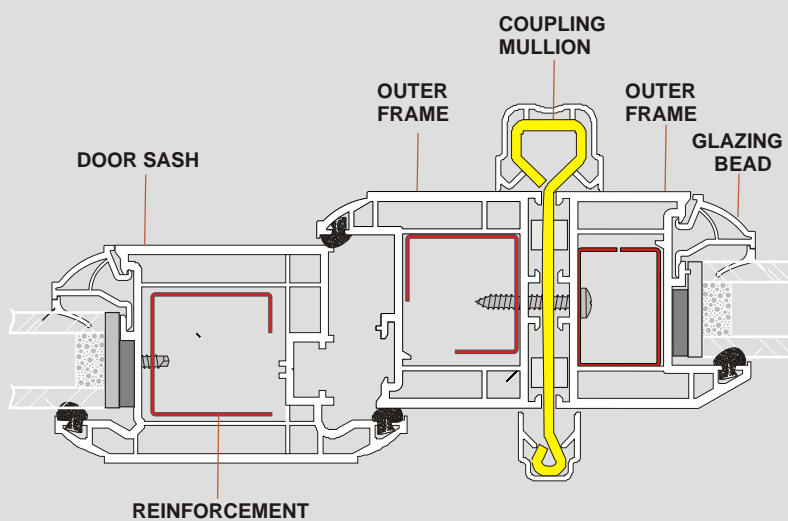

### Installation Packers

- Used adjacent to fixing positions to prevent frame distortion. Must be made of a material which is resistant to compression, rot and corrosion.

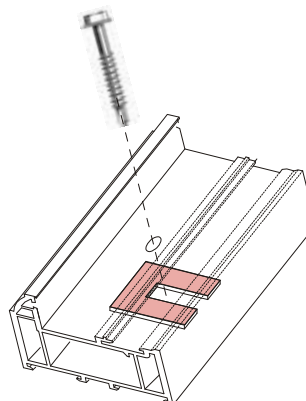

## General: Installer

### ■ **Finishing Off & Making Good**

Drainage paths should be cleared of any debris.

Internal reveals made good in accordance with the agreement between installer and purchaser.

Remove protective tape from the window / doorset on completion of installation.

### ■ **Sealing**

Perimeter joints should be sealed on both the inside and outside. The sealant should:

Adhere to the frame surface

Adhere to the structure

Accommodate joint movement

Withstand exposure to weather.

The British Adhesives & Sealants Association publish a guide to BS ISO 11600:2003 which is the Standard for classification and requirements for sealants. Also see BS 6093.

Three key performance criteria are identified.....

Movement Capability

Modulus (i.e Low)

Elasticity (i.e High)

Other criteria for window sealant includes.....

flow, loss of volume & mass, adhesive strength etc

Specialist sealant companies may be required for some applications.



### ■ **Final Inspection**

Should be carried out preferably accompanied by the purchaser / owner, and ensure that the installation is in accordance with the surveyors / manufacturers instruction.

Make the purchaser / owner aware of how to operate the door / window furniture.

## General: Installer

### ■ Glazing

All glazing should conform with the BS6262 and BS 8000-7 documentation.

Support the glass units correctly in accordance with BS 6262 with glass support and packing blocks.

Examine all glass units for damage prior to installation. Defective units should not be used.

Insulated glass units incorporating safety glass should be installed with the safety glass on the appropriate side. (Note, the marking of the safety unit must remain visible after installation).

Insulated units with Low emissivity coating should be installed in conjunction with the manufacturers instruction. Failure to do so may make the coating less effective.

### ■ Window/door packing configurations

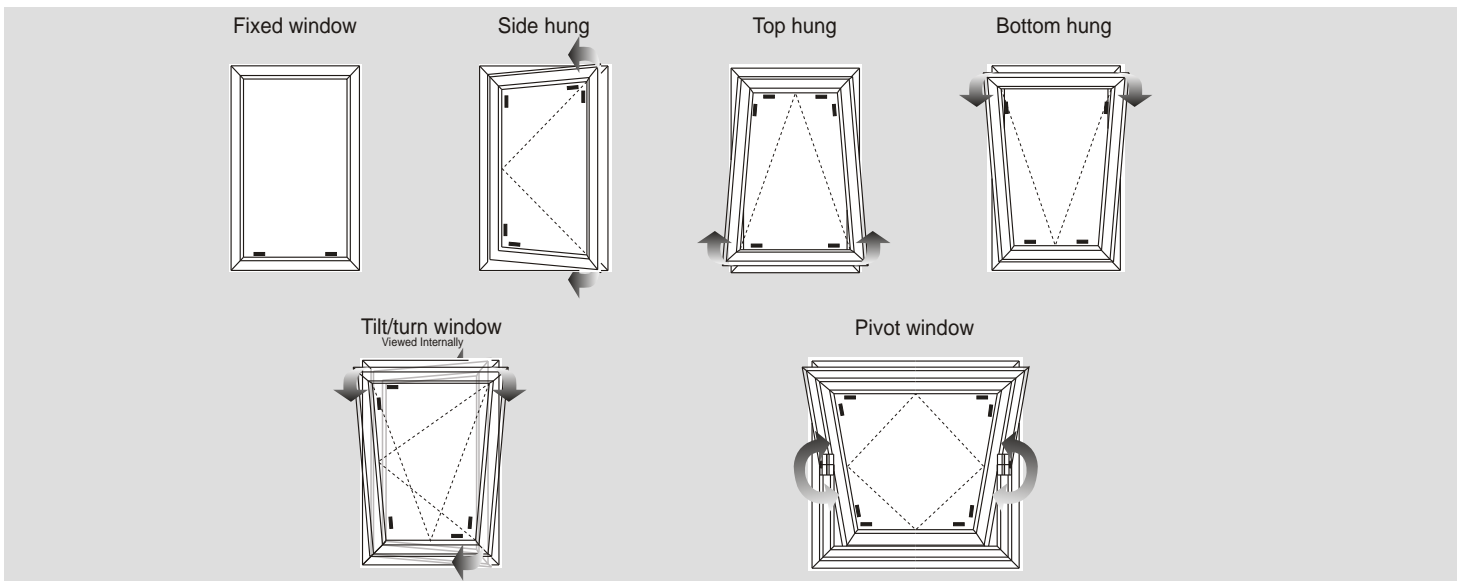

Note: All sashes should be packed at a maximum of 75mm from the corners in order that the dead load applied by the sealed units weight is distributed correctly.

Residential door

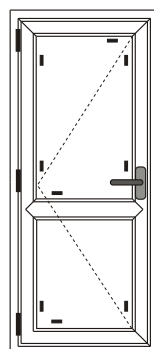

French door

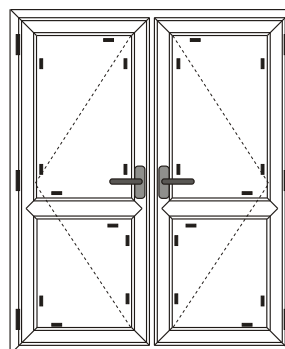

See BS 6262 for further window configurations and styles.

## Surveyors Checklist

	Y / N
■ Have risk assessment (s) been completed (See BS 8213-4: 2007)?	
■ Is the condition of the aperture satisfactory and without evidence of damp / cracks?	
■ Is the aperture square and even within 5mm height and width and 10mm diagonals?	
■ Will any loads be carried by the building and not the window / doorset?	
■ Has the size and method of fixing any sub-cill been determined?	
■ Will the window / doorset function without being fouled by plasterwork etc?	
■ Will any trickle ventilators fitted function without being fouled by plasterwork etc?	
■ Will hinges functions without being fouled by plasterwork?	
■ Are curtain tracks and nets clear of the proposed design?	
■ Is the size and configuration within the manufacturers limits?	
■ Will the products exposure category be suitable for the location?	
■ Will the installation conform with the Building Regulations?	
■ Is the method of drainage appropriate for the installation and product?	
■ Has the purchaser confirmed position and handing of the opening lights?	
■ Has any additional hardware been specified?	
■ Is the access to the installation safe?	
■ Has the fixing method of the window / doorset been determined?	
■ Has the extent of "making good" been agreed with the purchaser?	

**Note: It can be of benefit to make a photographic record of the existing installation in case of dispute over Building Regulations compliance at a later date**

## Final Inspection Checklist

		Y / N
<b>Visual Appearance</b>	■ Is the frame installed plumb and square?	
	■ Are the beads fitted correctly and evenly?	
	■ Are exposed faces - including beads - free from damage?	
	■ Is the frame clean with all protective tape removed?	
	■ Has any damage to the aperture been correctly made good?	
	■ Have all trims internally / externally been fitted correctly?	
	■ Has all site debris been removed?	
<b>Glazing</b>	■ Is all glazing as specified on the contract?	
	■ Are all sealed units free from scratches and damage?	
	■ Are obscure and coated glasses fitted correctly?	
	■ Are sealed unit spacer bars covered evenly by frame and beads?	
	■ Is the glazing held properly by the beads / gaskets etc?	
	■ Has safety glass been used where necessary?	
<b>Operation</b>	■ Do all sashes open / close and lock as intended?	
	■ Are seals on the frames fitted correctly and without gaps?	
	■ Are cams free from binding against the strikers?	
	■ Is all operating gear lubricated as necessary?	
	■ Is all hardware attached with correct number of fixings?	
<b>Sight Lines</b>	■ Are all sight lines visually correct?	
	■ Are opening lights aligned correctly?	
	■ Are all decorative features e.g leading, correctly aligned?	
<b>Sealing</b>	■ Are all joints smooth and correctly formed?	
	■ Is the sealant continuous around the perimeter of the frame?	
	■ Is the frame face free from excess sealant?	
<b>Drainage</b>	■ Are all drainage channels correctly positioned and free from obstruction?	
<b>Miscellaneous</b>	■ Are sub-cill end caps fitted if required?	

## Timber Windows / Doorsets

Glazed fixed light: Preferred method is removal of putty, sprigs, beads or fixing nails and removal of glass intact. Alternatively, carefully break the glass so that the fragments are on the outside of the structure.

It is good practice to run a sharp knife between the inside face of the frame and the plaster adjoining the frame, to minimize damage to the plaster when the window / doorset is removed.

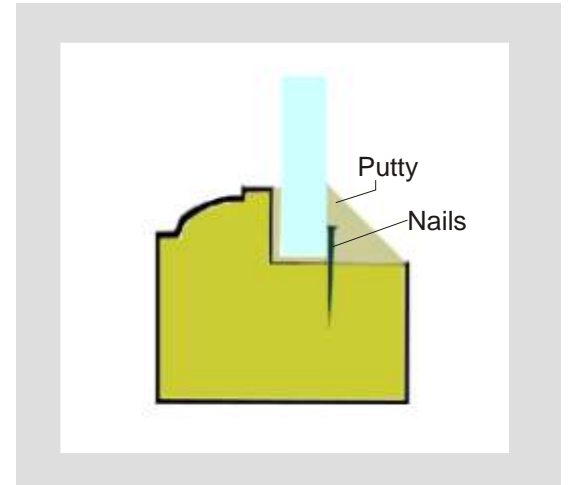

Remove opening lights first, complete with the glass by levering the screws from the frames, or unscrew the hinges or by cutting through the hinges. This provides a larger working space and reduces the weight of the window.

After removal of opening lights and fixed light glazing, any mullion / transoms which remain can be cut through in order to remove them.

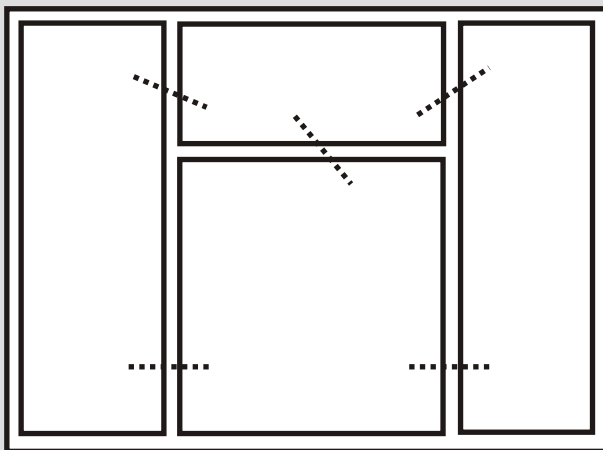

Cutting Through Transom / Mullions

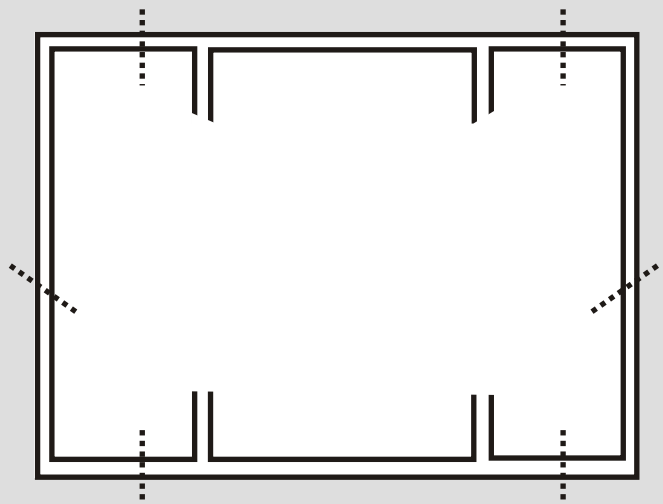

Cutting Through the Outer Frame

## Removal Techniques - Window & Doorsets

Problems may arise with windows/ Doorsets under the roof eaves. There might be a brick course resting on the frame between the top of the existing frame and the soffit board. This is generally decorative and not load - bearing.

### Box Sash Windows

Most box-sash windows were installed before cavity walls existed and are built into the internal reveals of the solid brickwork. The sashes can be removed fully glazed as follows...

- Remove mitred bead from around frame.
- Cut the sash cords to release and lower the weights.
- Remove bottom sash, take off parting bead, remove top sash.
- Cut outerframe from aperture leaving the horns in the structure.
- Remove counterweight from sash box



# Removal Techniques - Window & Doorsets

## Metal Window & Doorsets

Metal windows can be removed in one of the following ways.....

**If the window / doorset is fixed through the frame into timber sub-frames or direct into aperture.....**

- Remove all glazing from fixed lights, separate and remove all opening lights from frames.
- Locate and remove screws holding frame in place.
- Remove timber sub-frame

**For metal windows / doorsets fixed directly into brickwork or concrete and held in place with lugs...**

- Remove opening lights with angle grinder / hacksaw if unable to Unscrew the fixings.
- Cut through the transoms / mullions and remove
- Remove the screws from the frame by drilling out the heads
- Cut through each side of the frame with an angle grinder and lever away from the wall taking care not to damage the fabric of the aperture

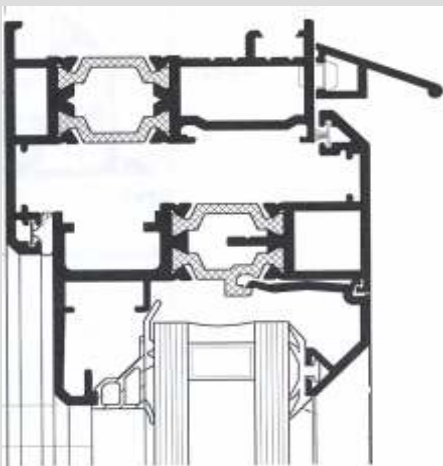

Typical Aluminium Window

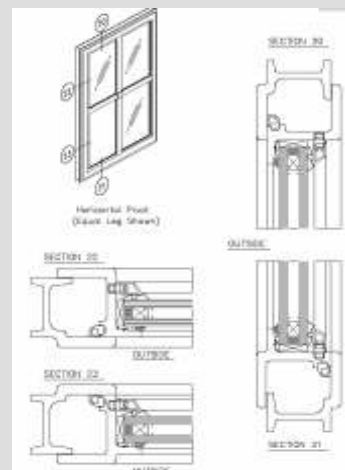

Typical Steel Window

# Removal Techniques - Window & Doorsets

## PVCu Window & Doorsets

Remove the glazing beads and remove the glass

Use a sharp knife to free the glass where glazing tape has been used

Remove opening lights by unscrewing the fixings.

Remove any trims in order to allow access and determine if fixing brackets / lugs are present.

- Through frame fixings - Unscrew to remove frame from aperture
- Fixing Lug / brackets - Unscrew the fixings, or if not possible cut bracket with angle grinder
- Special / Bespoke fixings may require instructions from the manufacturer

## Sub Cills

**Be aware of concealed D.P.M's (Damp proof membrane).** Care must be taken when removing the sub cill as not to damage the plaster, render and brickwork. If DPM is damaged upon frame removal, it must be repaired or replaced.

# Frame Positions and Joint Construction

**Flush Reveal With Joint Width Less Than 6.0mm, With Frame Bridging the D.P.M**

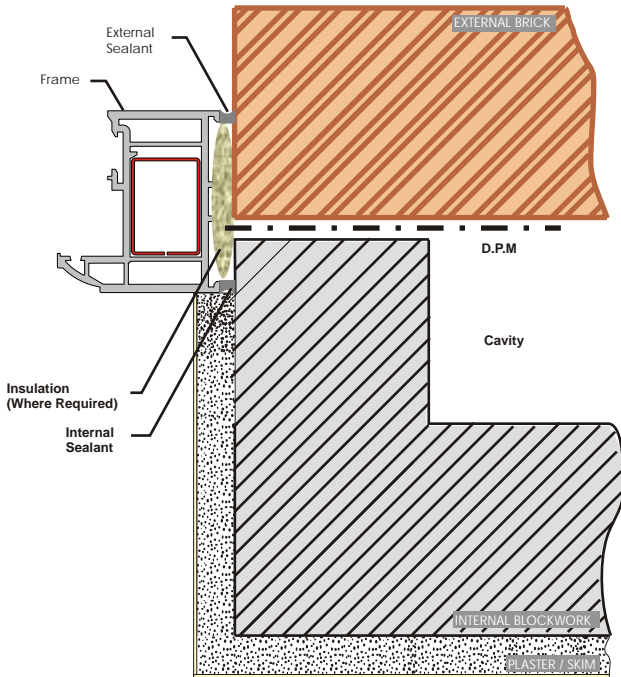

**Flush Reveal With Joint Width From 6.0mm to 15.0mm, With Frame Bridging the D.P.M**

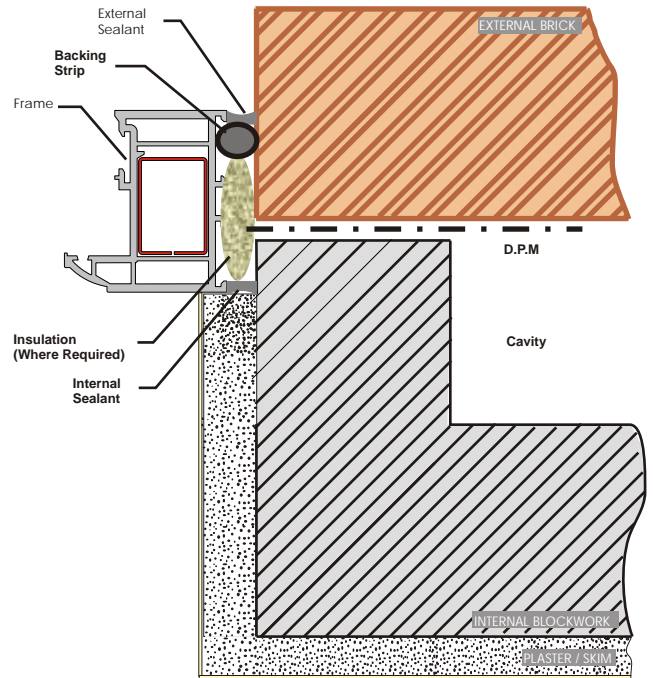

**Flush Reveal With External Render, For Replacement Frames**

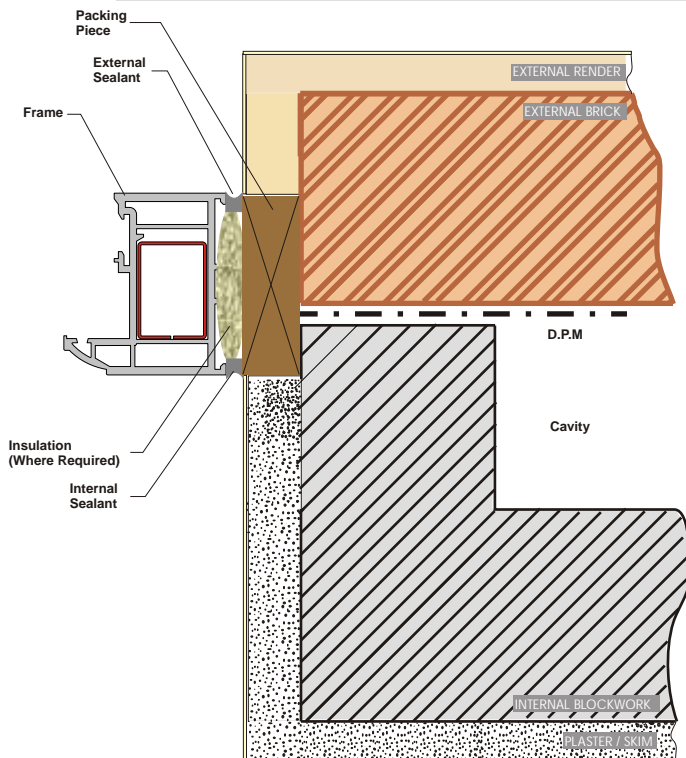

**Flush Reveal With External Render, For Replacement Frames Shuffled into Position**

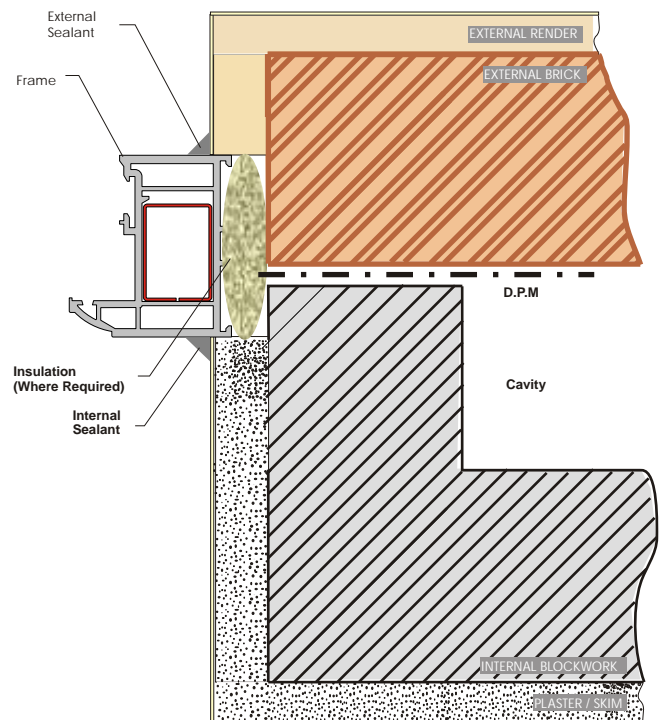



## Typical New Build Construction

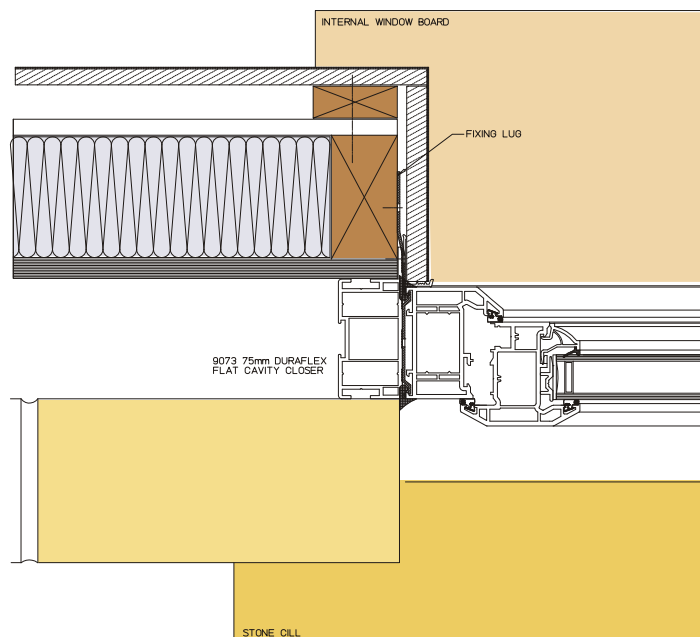
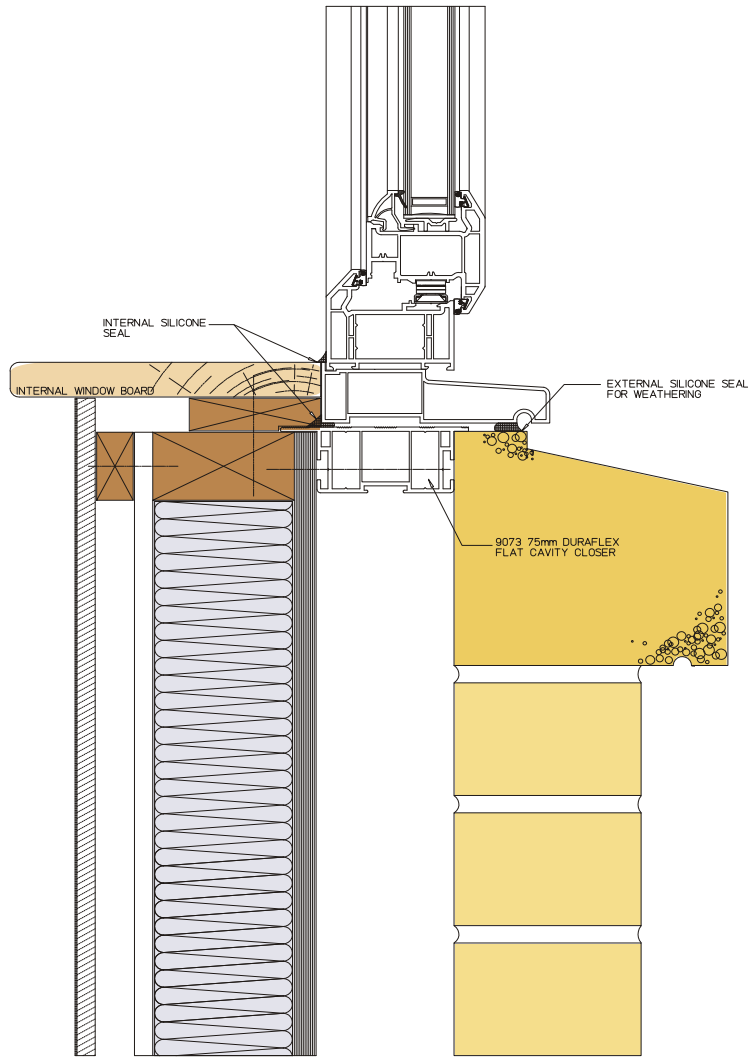





- BS 7412: Plastic Windows made from unplasticized polyvinyl chloride (PVC-u) extruded hollow profiles.
- PAS 23 - 1: General performance requirements for door assemblies.
- BPF Code of practice for reinforcement (323 / 1)
- BS 7950: Specification for enhanced security performance of casement and tilt / turn windows
- PAS 24 - 1: Enhanced security performance requirements for door assemblies
- BS EN 12608: Unplasticized polyvinyl chloride (PVC-u) profiles for the fabrication of windows and doors
- BS 7722: Surface covered PVC-u profiles for windows and doors
- BS EN 1670: Building hardware. Corrosion Resistance.
- BS 8213: Windows, doors and rooflights. Design for safety in use and during cleaning of windows, including door height windows and rooflights
- British Adhesives & Sealants Association: Good Practice in sealant application
- BS 6093: Code of practice for design of joints and jointing in building construction
- Health and Safety at work Regulations
- Construction (Design Management) Regulations
- Construction (Health, Safety and Welfare) Regulations
- Health and Safety (Work at height) Regulations
- Manual handling operation s regulations
- Control of substances hazardous to health regulations (COSHH)
- Electricity at work regulations
- Provision and use of work equipment regulations
- Building Regulations (England and Wales)
- Building Regulations (Scotland)
- Building Regulations (Northern Ireland)
- Accessible thresholds in new housing: A guide to Part M if the building regulations approved document

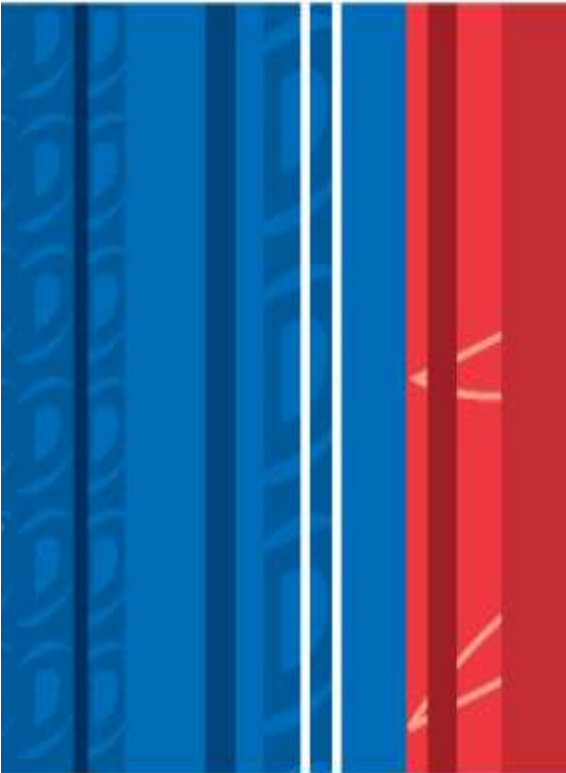

[technicalassist@duraflex.co.uk](mailto:technicalassist@duraflex.co.uk)



Duraflex Limited,  
Severn Drive  
Tewkesbury Business Park  
Tewkesbury, Gloucestershire GL20 8TX

Tel: 08705 351351 [www.duraflex.co.uk](http://www.duraflex.co.uk)

DURAFLEX LIMITED – A MASCO COMPANY